

240 Winch 5

User Manual



Index:

TECHNICAL SPECIFICATIONS:	3
CONTANT:	4
DESCRIPTION:	4
AREA OF USE:	5
OVERVIEW:	5
MODE FUNCTIONS:	5
DMX CHANNELS:	5
GETTING STARTED:	6
SETTINGS:	6
MOUNTING:	6
COUNTERBALANCE:	6
CONNECTION:	6
MANUAL RESET:	6
POSITIONING:	6
CONNECTING:	7
POWER:	7
DMX:	7
SETTINGS:	7
DMX ADDRESS:	7
MODE:	7
LAMPS:	7
DMX LAMP:	7
POSITION LAMP:	7
MODE FUNCTIONS:	8
TECHNICAL EXPLANATION AND THE DMX-CHANNELS	9
SYNCHRONIZED MOVEMENTS OF MULTIPLY WINCHES	11
CONTROLLING THE TOP- AND BOTTOM-POSITIONS:	12
INSPECTIONS AND MAINTENANCE:	13
FAULTS – DEFECTS:	15
WIRE DEFECT:	15
CHANGING WIRE:	15
APPLYING WIRE:	16
POWER DEFECT:	16
CHEAT SHEET	17

Technical specifications:

Item No.	: 240
Dimensions	: 240 x 210 x 150 mm. / 9.5 x 8.3 x 5.19 in. (L-W-H) (Without mounting clamp)
Power supply	: 230 V AC 50 Hz (optional 120V/60Hz).
Power consumption	: Max 200 Watt.
Power plug	: Neutrik powerCON male
DMX Control signal	: DMX 512 1990 + DMX512A / 7 channels used.
DMX connection	: 5 pole XLR, In & link
Lifting height	: 10 m. (33 ft.)
Lifting capacity	: 5 kg. (11 lbs.)
Lifting speed	: Variable, 5-55 cm/sec. (2-22 inch/sec.)
Noise emission	: ~55 dB
Weight	: 5.2 kg (11.5 lbs.)
Motor	: 24 V DC, 30.9 W, IP30
Lifting wire	: 1.5 mm Galvanized wire, 8mm snap hook. Calculated breaking strength: 240 kg
Mounting clamp	: Slim eye coupler (Max load: 300 kg) 50 mm (2 inch.)

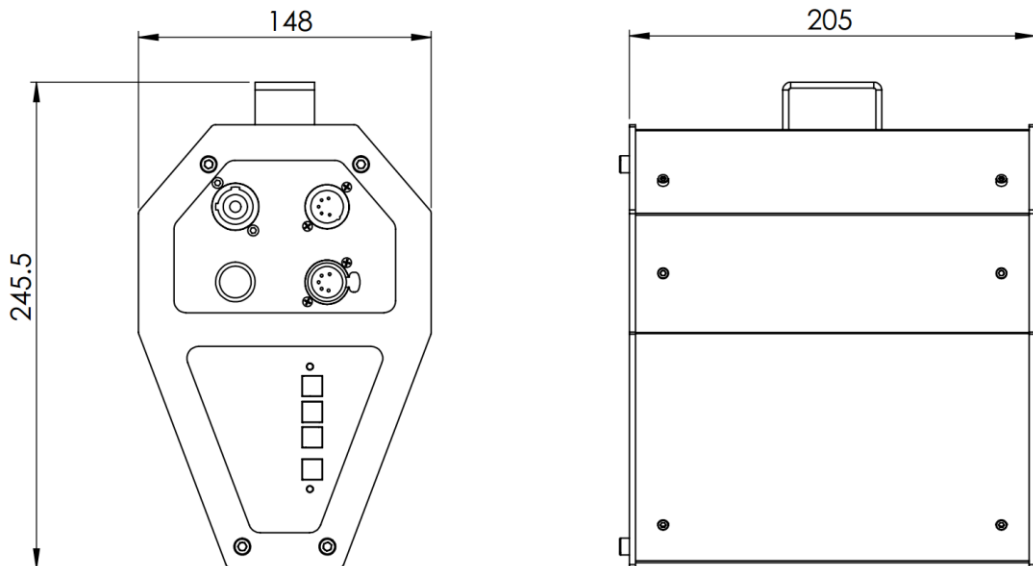

General:

Before using the winch for the first time, please read the installation- safety- operation- and maintenance instructions carefully. Failure in handling can cause injury of persons and/or damage the winch.

Content:

1 Winch 5
1 Manfrotte Slim coupler
1 Mounting bolt and nut (M12) for slim coupler attachment
1 Powercon plug for cable
1 Instruction manual

Description:

Winch 5 is a mini winch for stage use, mainly in connection with theatres, shows and concerts. It lifts props and small set pieces in and out of the stage sphere at max. load of 5 kg up and down. The standard lifting height is 10 m but it can be extended to 15 m without further risks.

The lifting speed is between 1 cm/sec. and 60 cm/sec.

The winches are easily connected as a chain, allowing for advanced and creative ways of making dynamic movements.

The winch is controlled by the DMX channels from the lighting desk. It has a built-in positioning system which is utilized in locating the desired position. The positioning system is controlled from a 16 bit DMX channel and is highly accurate; the winch stops within 1 mm. The speed of the winch is likewise controlled from the lighting desk, and it is possible to set the upper and lower limits of the movement of the winch, adjusting its span of motion.

7 DMX channels controls the wanted position and the speed of the movement, and the winch finds the position applied on the lighting desk. The movements are programmed as lighting and in interaction with the light.

The steering system ensures that the motor only is powered when:

- The steering signal is reliable.
- The position and speed control is on.
- The motor position is calculated after with a PID regulator calculates the motor speed and distance.
- No overload.

Winch 5 should only be operated by an experienced DMX-controlled-lighting-desk-operator.

The lighting desk has to be programmed according to the manual, so the winch will stop when the speed is put to 0 %. It is also possible for the user to stop the winch on the main.

After power failure the start position of the winch should be reset.

Manually running of the winch is only intended for mounting, service and tests.

Area of use:

The Winch is intended for indoor use. It is designed for lifting and lowering material at the weight and speed stated in "Technical Data". Any other use of the winch may result in a risk of injury of persons or equipment damage.

Exceeding the load rating may cause failure of the equipment.

Use only approved rigging connectors to secure the load to the wire and do not wrap the wire around the load as this will damage the wire and result in a risk of injury of persons or equipment damage.

Do not modify the winch. Any modification you might need should be done by Wahlberg.

It is the customers' responsibility that any local restrictions concerning the use of the winch are complied with.

For indoor use only!

Caution: "To Reduce the Risk of Electric Shock or Injury, Use Indoors Only."

Caution: "To reduce the risk of electric shock, do not expose to rain. Store indoors."

Overview:

MODE functions:	
MODE 1	Positioning with auto reset.
MODE 2.	Positioning with manual reset
MODE 7	Manual run up (no DMX needed).
MODE 8	Manual run down (no DMX needed).
MODE 3, 4, 5, 6	Only if specified, otherwise the motor stops.
DMX channels:	
DMX channel 1	Position rough. (Hi of a 16 bit DMX channel).
DMX channel 2	Position fine. (Lo of a 16 bit DMX channel).
DMX channel 3	Max speed.
DMX channel 4	Max travel top.
DMX channel 5	Max travel bottom.
DMX channel 6	Find TOP position, moving UP
DMX channel 7	Moving DOWN

Attention!

Before running the winch, it is important to put a counterbalance on the wire.

Either by putting some kind of weight in the snap hook or by manually holding the wire back.

This is important, as the slack detection switch otherwise will be activated and the winch will not run

Getting started:

If you are using the winch5 for the first time it is a good idea to read this, to learn how to get started properly and what to pay extra attention to.

Settings:

The settings of the winch should be the first thing to setup. Both the setting of the MODE function and the DMX-address should be set before mounting the winch.

In this section we describe MODE 2.

Mounting:

The winch should be mounted to a ceiling or likewise, with the mounting clamp at the top of the winch.

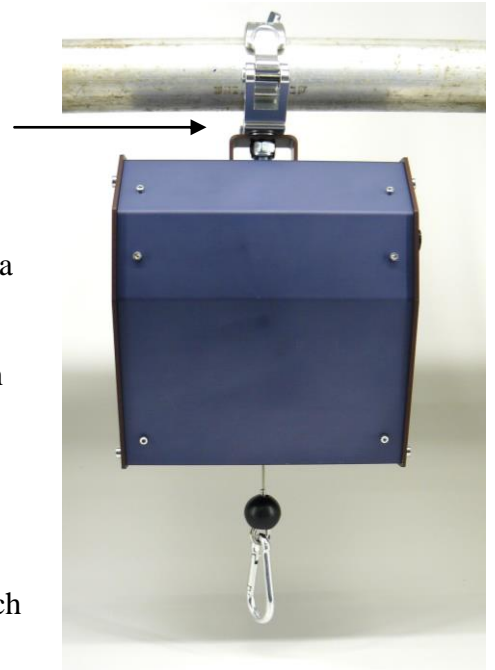

Counterbalance:

When the winch has been mounted, it is important to hook on a counterbalance before running with it. This can be done by hanging some sort of weight in the snap hook at the end of the wire. The counterbalance is very important, because the winch will not run without it.

Connection:

When the winch has been mounted and a counterbalance has been placed, both power and DMX signal should now be connected, as described in the passage **Connections**. The winch is now ready to roll.

Manual reset:

When the winch is ready, the first thing to do is to reset it. This is done manually in MODE 2 on DMX channel 6 and 7.

Reset example:

The DMX channel 6 is set at 30% - The winch runs up. Let it run until the snap hook, at the end of the wire, reaches the motor-house. Decrease the speed at DMX channel 6 as the end of the wire closes in on the motor-house. High speed could damage the winch and/or wire or blow the fuse.

The winch is now reset and the top-position is at the motor-house or where the motor was stopped.

Positioning:

When the winch has been reset and the top-position is set, it is possible to use it for positioning run. The position is set on the DMX channel 1 and 2, which controls the rough- and fine-position. Where 100 % is the top-position and 0 % is the bottom-position. The speed is set on the DMX channel 3, where 100 % is the fastest and 0 % is the slowest. The winch doesn't run unless the DMX channel 3 is set above zero, and therefore also works as a main brake. To get the most accurate run in proportion to the top- and bottom-positions, read the passage **controlling the top- and bottom-positions**.

Connecting:

Power:

The winch is connected to 230VAC, by the enclosed Powercon plug. When the power is correctly connected, the green lamps on the winch are blinking.

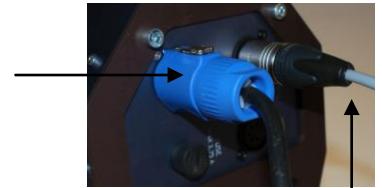

DMX:

DMX is connected by the 5 poled XLR plug on the front of the winch (DMX IN). The DMX lamp will glow constant, when the connection is correct.

Settings:

DMX address:

The DMX address is set on the 3 DMX-selectors on the front of the winch. The selected DMX address states from which channels, on the lighting desk, the winch is controlled. The DMX address can be selected from 1 – 505. The winch uses 7 DMX channels in total.

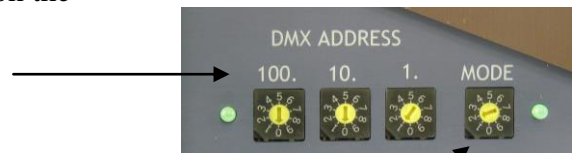

MODE:

The wanted MODE function is set on the MODE-selector on the side of the winch. Each MODE states a certain function. (See under **MODE functions**).

Lamps:

DMX lamp:

The DMX lamp is the green led, next to the DMX-selectors. The DMX lamp will glow constant if the DMX signal is connected correctly. The DMX lamp will flash if the DMX signal is missing or wrongly connected.



Position lamp:

The position lamp is the green led, next to the MODE-selector. The position lamp indicates, by fast flashing, that the winch needs to be reset, before it can be used. The positions lamp indicates, by slow flashing, that the winch has been reset and that it is going towards the wanted position. The position lamp indicates, by stable light, that the winch has found the wanted position and the motor has stopped.

MODE functions:

Each MODE setting has a given function. Each mode gives an opportunity for different run settings with the winch.

The winch needs to be reset, before the positioning mode is possible. The winch can be reset manually or automatically. The winch must be reset each time its power supply has been disconnected. Read the passage about **controlling the top- and bottom-positions**, to explore and setup the winch best for your own particular need.

MODE 1:

Positioning with AUTO reset.

The winch resets automatically and thereby also sets the top-position automatically. The winch runs up until the snap hook reaches the motor-house and stops. Because of this, the top-positions in this MODE will always be at the motor-house. To start the automatic resetting, speed must be added on the speed-channel (DMX channel 3).

When the winch has been reset, it is possible to use it in positioning mode.

MODE 2:

Positioning with MANUAL reset.

The winch is manually reset on the DMX channels 6 or 7. The top-position is, because of this, also set manually, which makes it possible to decide the position of the top-position.

We suggest anyway that it is set near by the motor-house.

When the winch is being reset, it is important to decrease the speed, as the snap hook is closing in on the motor-house, otherwise the wire and winch can be damaged.

When the winch has been reset, it is possible to use it in positioning mode.

MODE 7:

Manual run up (no DMX needed)

The winch runs up with the speed set on the DMX-selectors. This function can be used as a test-function or in association with on- and off-applying of wire.

E.g. Set the winch to MODE 7 and the DMX address to 100, for a slow movement, or set the DMX address to 500 for fast movement.

MODE 8:

Manual run down (no DMX needed)

The winch runs down with the speed set on the DMX-selectors. This function can be used as a test-function or in association with on- and off-applying of wire.

E.g. Set the winch to MODE 8 and the DMX address to 100, for a slow movement, or set the DMX address to 500 for fast movement.

Technical explanation and the DMX-channels

The winch5 uses 7 DMX channels in total.

The start channel is set on the 3 DMX-selectors.

The 7 channels are used in the following way:

DMX channels:	
DMX channel 1	Position rough. (Hi of a 16 bit DMX channel).
DMX channel 2	Position fine. (Lo of a 16 bit DMX channel).
DMX channel 3	Max speed.
DMX channel 4	Max travel top.
DMX channel 5	Max travel bottom.
DMX channel 6	Find TOP position, moving UP
DMX channel 7	Find TOP position, moving DOWN

OBS: as an extra safety under positioning run, it is possible to remove the DMX signal, which will brake and stop the motor.

DMX channel 1 – Position rough:

The channel controls the position of the winch, with the speed set on the DMX channel 3.

This rough position works together with the fine position (DMX channel 2). The rough position and the fine position are multiplied in to a 16 bit channel. The rough position is the MSB.

DMX channel 2 – Position fine:

The channel controls the position of the winch, with the speed set on the DMX channel 3.

This fine position works together with the rough position (DMX channel 1). The fine position and the rough position are multiplied in to a 16 bit channel. The fine position is the LSB.

DMX channel 3 – Speed:

The channel controls the speed of the winch.

The channel defines the maximum speed. The winch runs with the set max speed, but slows down as closing in on the wanted position. This channel also works as a main brake, the motor does not run unless the channel is set above 0%.

The speed-channel can also be used to make soft and slow movements or fast and sudden movements.

DMX channel 4 – Max travel top:

The channel controls the maximum top travelling height of the winch. When the winch has been reset and the top-position thereby has been declared, it is possible, by adjusting this channel, to change how high the winch may run in proportion to the top-position. So the top travelling height for the winch is changed. Where 0% declares the **maximal** top travelling height, which means it runs all the way up to the reset top- position. Where 100% declares the **minimal** top travelling, which means it is as far from the reset top-position as possible. By adjusting this channel the positioning run from 0 - 100% will be within this new parameter. The top travelling height can be changed as needed, without resetting the winch top-position.

DMX channel 5 – Max travel bottom:

The channel controls the maximum bottom travelling height of the winch. When the winch has been reset and the top-position thereby has been declared, it is possible, by adjusting this channel, to change how low the winch may run in proportion to the bottom-position. So the bottom travelling height for the winch is changed. Where 0% declares the **maximal** bottom travelling height, which means it runs all the way down to the reset bottom-position. Where 100% declares the **minimal** bottom travelling, which means it is as far from the reset bottom-position as possible.

By adjusting this channel the positioning run from 0 - 100% will be within this new parameter. The bottom travelling height can be changed as needed, without resetting the winch top-position.

DMX channel 6 – Find TOP position, moving UP:

The channel is used to manually finding the top-position. The channel controls the speed from 0 – 100%. The winch starts to run up when channel 6 is set above 0 %.

When the winch reaches the wanted top-position, the speed must be set to 0 %, so that the motor stops. The top-position of the winch is thereby set, where the motor has been left at. The top-position should always be near by the motor-house. See more details in the passage **controlling the top- and bottom-positions.**

The positioning run in MODE 2 only works, when the winch has been reset.

DMX channel 7 – Find TOP position, moving DOWN

The winch starts to run down when the speed is set above 0 %.

This can be used to manually move the winch down without using positioning.

Synchronized movements of multiply winches

If several winches are installed to perform synchronized movements some tricks are needed to get the best result.

By nature the motors perform mostly equal, but some motors are running faster at full speed than others.

To get around this issue a fading 16 bit position is needed.

Like when fading light, the positions of the different winches should be faded, and the winches will tend to follow that fade.

When fading the positions the speed channel should be a 100, to gain the highest possible speed.

Also the position channel should be added like a 16 bit channel and not just the MSB on channel 1.

The speed of the fade needs to be slower than the maximum speed, so the motors have speed enough to perform the movement.

If the fade of the positions is too fast, the winches will move at the maximum speed, and you will see the difference in the motor speed.

If the fade is too slow the winches will move – stop – move – stop, when the position changes, thus giving a very bumpy movement.

Controlling the top- and bottom-positions:

The top-position needs to be reset automatically or manually, before it is able to use the winch for positioning run. To get the most precise run, fit for your own needs, it is possible to regulate the top- and bottom-positions.

The top-position is reset manually by the DMX channels 6 or 7. When the top-position is being reset it should always be set near by the motor-house.

This is important to notice because the winch has a preset bottom-position, which is always set 10meters from the reset top-position. Therefore, if the top-position is set far from the motor-house and the bottom-position is not adjusted, the winch will still run 10m. (33ft.) down and eventually run out of wire. This will cause a problem, as the slack detection will kick in and the winch will not go any further down.

To avoid this situation the max travel to the top and the bottom should instead be adjusted on DMX channels 4 and 5.

***OBS:** If these two spectrums overlap the max top position overrules the max bottom position and the winch will move down to that position, but will be unable to be moved with normal positioning, because the operating spectrum has been reduced to 0.*

DMX channel 4	Meter from the top position	DMX channel 5	Meter from the bottom position
0 %	0 m (0 ft)	0 %	0 m (0 ft)
10 %	0,3 m (1.0 ft)	10 %	1 m (3.3 ft)
20 %	0,6 m (2.0 ft)	20 %	2 m (6.6 ft)
30 %	0,9 m (3.0 ft)	30 %	3 m (9.8 ft)
40 %	1,2 m (3.9 ft)	40 %	4 m (13.1 ft)
50 %	1,5 m (4.9 ft)	50 %	5 m (16.4 ft)
60 %	1,8 m (5.9 ft)	60 %	6 m (19.7 ft)
70 %	2,1 m (6.9 ft)	70 %	7 m (23.0 ft)
80 %	2,4 m (7.8 ft)	80 %	8 m (26.2 ft)
90 %	2,7 m (8.9 ft)	90 %	9 m (29.5 ft)
100 %	3 m (9.8 ft)	100 %	10 m (32.8 ft)

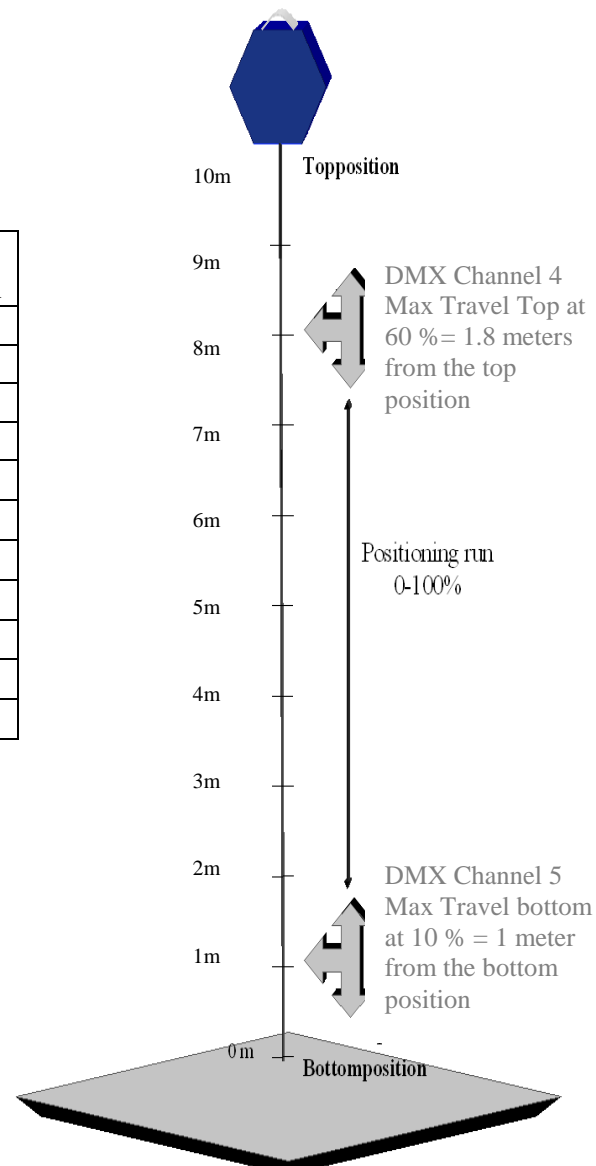

Inspections and Maintenance:

Interval of inspections should be determined according to the frequency of use and the working scenario of the winch.

If the wire runs in an angle it wears down faster.

Signs of malfunction or poor operation should always lead to an inspection of the winch, and the winch should be taken out of operation until the error is eliminated.

Maintenance plan:

Before every use and Weekly:

Every time when rigging the winch, before running the winch – and at least every week when the winch is in use:

- Check the entire length of the wire rope for bends, crushed areas, broken or cut cord, corrosion and other damages.
- Check all safety devices.
- Check that the wire is wound neatly on the drum.

Monthly:

At regular intervals – but at least every month when the winch is in use:

- Check the mounting clamp and snap hook for damages and proper fastening.
- Make sure the snap hook opens without binding and closes when released.
- Change damaged parts. See the passage "Faults – detect".

Every 12 month:

The winch has to be inspected by a specialist every 12 months

Every 48 month:

The winch should be inspected by an authorised expert every 48 months.

The results of the regular inspections are to be documented and kept available at the company. The written result of the last inspection must be kept available at the site of operation, e.g. by an inspection sticker on the winch showing the date of the inspection, the basis of the inspection and the name of the inspector.

Life of the wire:

The life of the wire is depending on the load on the wire and the working scenario – handling, stress, environment etc.

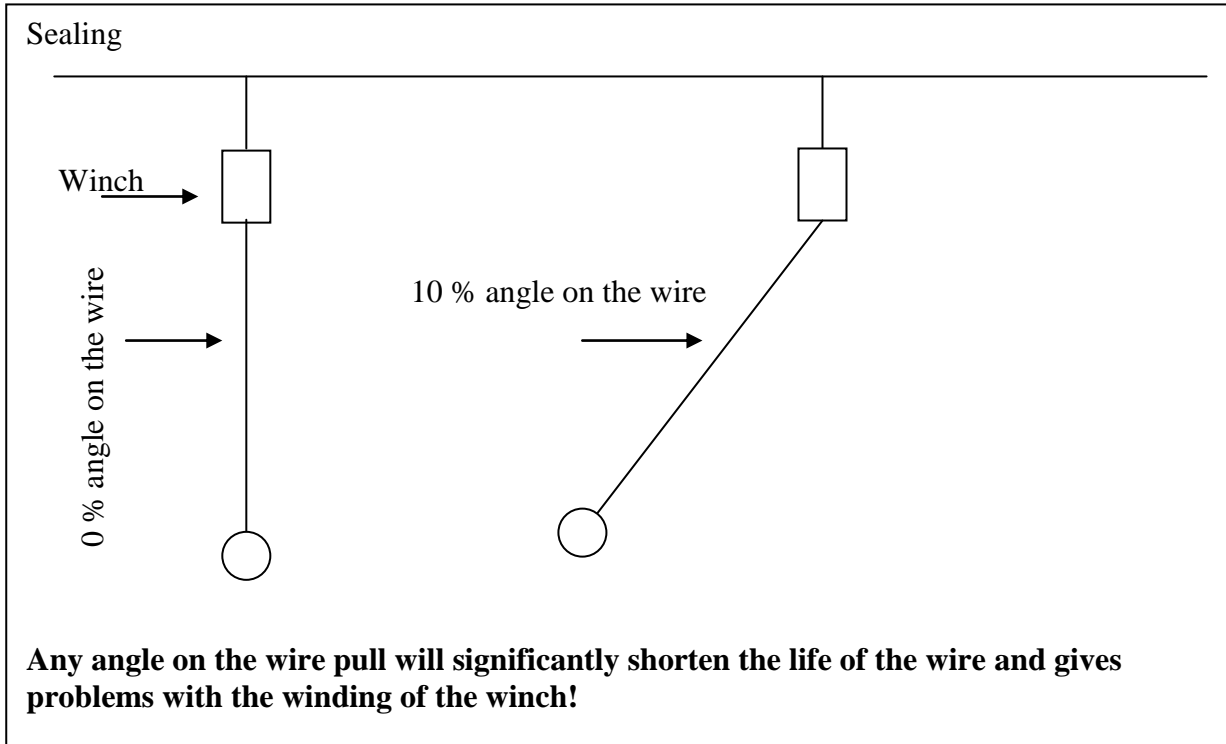

Spare parts:

Only parts ordered at or approved by Wahlberg to be used.

Faults – defects:

Wire defect:

If the wire in some way should get damaged, get stuck or have problems rolling on and off, the winch needs to be opened, so it becomes possible to check if the wire is loose or if it is bungled up inside.

This can be done the following way:

Disconnect the power.

Loosen the four 5mm hexagonal socket screws, on one of the sides on the winch.

Remove the six 3mm hexagonal socket screws, on one of the middle plates on the winch.

Take off the loose middle plate, to look into the winch.

See the picture to the right.

If the wire is not tight around the wire-wheel, or it is bungled up inside the wire needs to be unravelled. This is done by manually unravelling and loosening the wire and pulling it out of the winch. It can be necessary to remove the other middle plate to work it out of the winch properly.

If the wire is bended and damaged, it has to be replaced.

Read the next passage **Change wire**.

If the wire is okay it must be rolled on again.

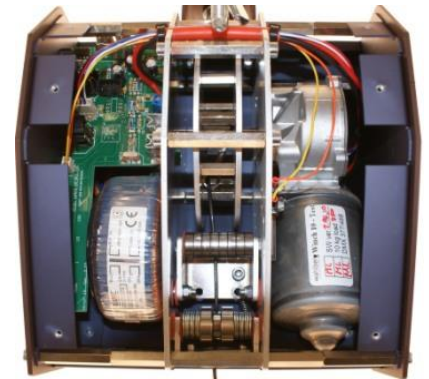

Changing wire:

If the wire is damaged it must be replaced.

First it must be rolled off.

This is done with MODE 8 (Manual run down).

To get inside of the winch read the previous passage **Wire defect**.

The new wire must be put around the wire-wheel.

Form an eye around a thimble using two ferrules and an appropriate swaging tool. The wire is then put around the centre of the wheel, by pulling the other end of the wire through the eye. Tighten the wire around the wheel. Put the free end of wire through the slackdetection and the wire guard in the bottom of the winch and pull it out. Hereafter the wire must be rolled on – See the passage **Applying the wire**. When the wire end is close to the wire guard apply the wire stop and make an eye for the snap hook as described above. Place the wire stop over the ferrules.

Roll on the remaining wire at slow speed.

Remember to put back the side cover and tighten the screws.



Applying wire:

To applying the wire, the power must be connected again. Before this is done, it is important that the MODE-setting on the winch is set in a neutral function (MODE 0) to make sure the motor does not suddenly start.

***OBS:** Be careful not to touch the power supply inside the winch, as it is exposed. This can cause an electric shock and damage the winch.*

When the power is connected, the manual run function must be used.

Set the DMX start address to zero (000)

Set the MODE to manual up (MODE 7)

Set the speed on the DMX address - Suggested address is 100, which is a fine slow speed and easy to follow.

When the motor starts and the wire is rolling on, it is important to hold on to the wire and thereby making a counterbalance, so the wire will roll on tightly around the wire-wheel.

Make sure not to bend or damaged the loose wire as it rolls on.

When the wire has rolled on all the way, disconnect the power or set the speed (DMX start address) to zero (000).

***OBS:** Be careful not to get fingers or likewise caught in the wire-wheel as it turns. This can damage you and the winch.*

When the wire has been applied to the winch again it is a good idea, to run up and down a couple of times, before assembling it again. Remember always to make a counterbalance in the wire when running with the winch, as this is often the reason why the wire gets loose and tangled up in the first place.

Power defect:

If the winch does not react when the power is connected check the following:

Check that the power plug is properly connected, both to the POWER IN plug on the winch and to the main power plug.

Check that the fuse is intact. It can be replaced with a new 2A fuse.

Check that the fuse is tightly screwed on in the fuse cap, also if it has just been changed.



Cheat Sheet

MODE functions:	
MODE 1	Positioning with auto TOP reset.
MODE 2.	Positioning with manual top reset (factory setting)
MODE 7	Manual run up (no DMX needed).
MODE 8	Manual run down (no DMX needed).
MODE 3, 4, 5, 6	Only if specified, otherwise the motor stops.
DMX channels:	
DMX channel 1	Position rough. (Hi of a 16 bit DMX channel).
DMX channel 2	Position fine. (Lo of a 16 bit DMX channel).
DMX channel 3	Max speed.
DMX channel 4	Max travel top.
DMX channel 5	Max travel bottom.
DMX channel 6	Find TOP position, moving UP
DMX channel 7	Moving DOWN

How to get started.

- 1: Place / Rig the winch in something high with minimum 2-3 meter below.
- 2: Put on counterweight on the winch hock, minimum 1 kilo.
- 3: Set the DMX start address to 001, and the MODE to 2.
- 4: Apply DMX from a Lighting desk, best is a desk with manual faders.
Make sure that your 7 channels are patched from DMX channel 1 to 7.
Pull all channels to 0%
- 5: Apply power to the winch.
DMX lamp should be lit, and the mode lamp should be flashing.
- 6: Pull channel 6 to 20 % -- the winch starts pulling the wire
Stop (pull channel 6 to 0%) when the wire is at the top position (pulled into the winch)
NOW the winch has found its TOP position and is ready to drive with position control.
- 7: Pull channel 1 (position) to 95 %
Pull channel 3 (speed) to 20%
Now the winch start to move down, with 20% speed, to a position the is 95% up.
- 8: Pull channel 1 (position) to 80%
Now the winch starts to move down, with 20% speed, to a position that is 80% up.
- 9: Pull channel 1 (position) to 90 %
Pull channel 3 (speed) to 50%
The Winch starts to move UP again, with 50% speed, and stops 1 meter before the top.